

Instruction Manual



Please read this instruction manual carefully before using the product and keep it properly

Let Nature Back Indoors

Specifications

Net weight (Kg)	11
Gross weight (Kg)	13.5
Dimensions HxWxD (mm)	310 x 310 x 761.5

ELECTRICAL CHARACTERISTICS

1> Power supply requirements: 100~120Vac/50~60Hz or 220~240Vac/50~60Hz

2> Power consumption:

Mode	Power (W)
Night mode:	3
Speed 1	7
Speed 2	15
Speed 3	27
Speed 4	50

PERFORMANCE

1> Clean Air Delivery Rate*

Mode	CADR (m ³ /h)	CADR (CFM)
Night mode:	100	58
Speed 1	200	117
Speed 2	360	210
Speed 3	475	277
Speed 4	610	356

*+-10% of specified air delivery

2> Noise Level*

Mode	Noise Level (dB)
Night mode:	<30
Speed 1	31.5
Speed 2	37.5
Speed 3	45
Speed 4	52

*Noise level tested with ambient noise=30dB

3> Motor Fan type: BLDC

4> PM2.5 sensor Type: Laser

CONTROL PANEL FEATURES

Intelligent Filter & Biotic Life Monitor: **Yes**

Timer: **1~12H**

Auto Mode: **Yes**

Child Lock: **Yes**

Speeds: **1,2,3 and 4**

Sleep Mode: **Yes**

ENVIRONMENT (Operating conditions)

Operation temperature: -20°C to 45°C

Humidity 10% to 95% RH

FILTER CONFIGURATION

Certified Filtration Efficiency

Up to 99.97% for particles ≥ 0.3 microns (μm)

Bacteria Filtration Efficiency

99.997%

Filter Grade

H13 high efficiency filter, H14 is an option

Average Filter Life

10~13 Months

Security Information

⚠ Personal injury or property damage may be caused if the product is not used in accordance with the regulations. Please read the following carefully to prevent dangerous operation.

Machine placement:

- Before using the product, it should be placed on a dry, stable and stable floor, leaving at least 30 cm of space around the product.
- Do not place near curtains.
- Do not place in direct sunlight.
- Do not use this product in humid or high temperature environments such as bathrooms, toilets and kitchens.
- Do not immerse the product in water.

Power related

- This product is limited to use with 220~240Vac/50~60Hz or 100~120Vac/50~60Hz power supply.
- If the power cord is damaged, stop using it immediately and contact the service center.
- Do not pull the power cord to move the product.
- Do not touch the power plug with wet hands.
- If there is dust or water stains on the power plug, please wipe it with a dry towel.
- Please unplug the power plug when not in use for a long time.

User related:

- Do not spray flammable substances near this product.
 - Do not place anything on top of the product and do not sit or stand on the product.
 - Do not spray water directly on the product or use chemical cleaners such as alcohol, hydrochloric acid, etc. to clean the product.
 - When the product is abnormal, please unplug the power plug immediately and contact the maintenance center in time.
 - Do not block the air inlet and outlet of this product with any objects.
 - Do not block the detection hole of the air sensor.
- Be sure to stick your fingers or other objects into the air inlet or outlet.
- Please take good care of children and ensure that children do not play with this product to avoid accidents.
 - Alcohol, perfume, and cleaning agents may affect the air detection of this product, so please do not use them at the same time.
 - This product cannot replace natural ventilation or other electrical appliances such as vacuum cleaners, range hoods, etc.

Filter Replacement and Maintenance

Warning: CUT OFF THE POWER BEFORE REPLACING THE FILTER

When replacing the filter, only the original filter provided by our company can be used, and do not use other filters from other brands, otherwise, it may cause the performance of the product to decline or even damage the product.

Do not disassemble, repair or modify the product arbitrarily.

PM2.5 dust sensor replacement

When the PM2.5 dust sensor reaches its service life and the displayed value is inaccurate, only the original model PM2.5 laser sensor provided by our company can be selected. (Otherwise it may lead to product performance degradation or even product damage).

Operation of the BA-2080

1. Product buttons and interface:

1> Function key description

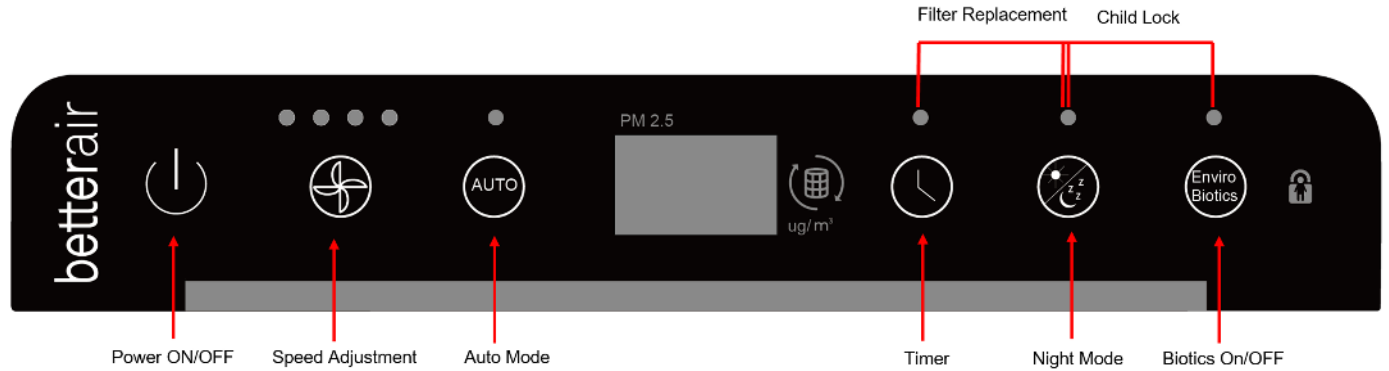

2> Display & Indicator description

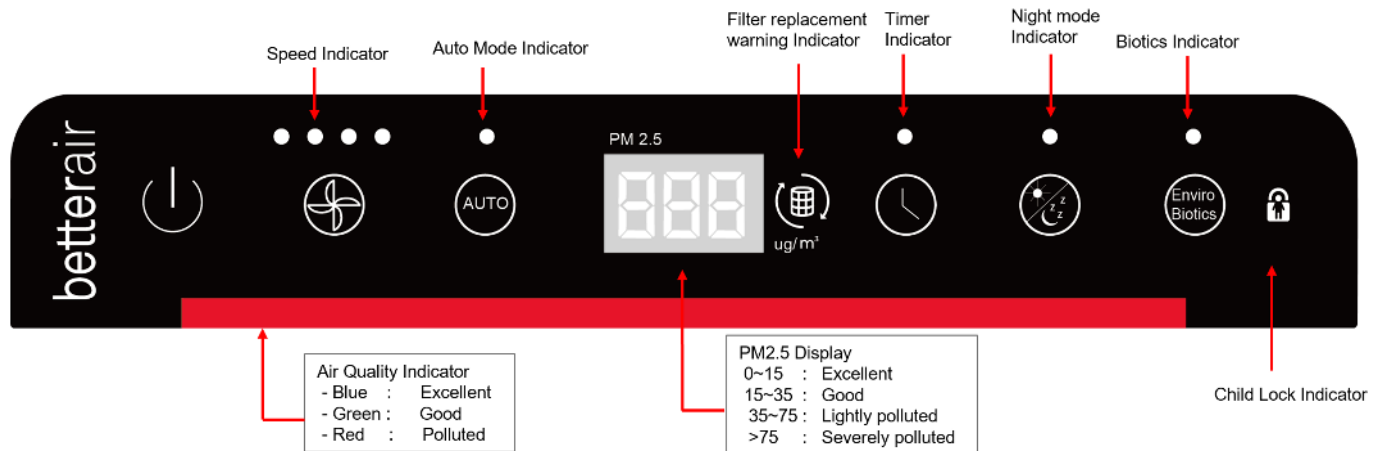

2. Power on the unit



After plugging in the power supply cable, the machine beeps once, all the indicators on the front panel flash once, the backlight of the power button is on, and all other indicators are off, the machine is in the standby state;

3. Power button

1>. Touch the power button once in the standby state, the backlight of the power button is on, the machine beeps once, and the machine enters the "AUTO" mode (by default, it starts to run at 2-speed wind speed).

2>. On each boot, the PM2.5 laser sensor enters the preheating stage. During preheating, the PM2.5 indicator is orange by default, and the PM2.5 digital screen displays 3 horizontal lines  ; PM2.5 data will show up on the screen after 15 seconds.

4. Speed Adjustment Button

Press the button in the power-on state, the machine starts to work in "1st gear", the 1st gear indicator  will on; Press the button again when working in "1st gear", the machine will switch to 2nd gear and the first 2 indicators  will be lighted up; same operation for 3rd and 4th gear.





5. Timer button

- 1>. Press the button in the power-on state, the digital screen starts to display from 1H to 12H when keep on pressing it
- 2>. Once the time is set, the machine will work in the current state. After the set time is reached, the machine will automatically shut down and return to the standby state.

6. Night mode button

- 1>. Press the button in the power-on state, the machine enters night mode
- 2>. Press any button will wake up the night mode, backlights of all the button and digital screen are on, if no button is activated within 5 seconds, the machine continues to work under night mode.

7. Child lock button

Press night mode and Enviro Biotics button together ( + ), the machine is locked, the child lock indicator () will on;
Press the two buttons again to quit from child lock mode, the child lock indicator will be off ().

8. Enviro Biotics button

The biotics operates automatically after power on or quit from night mode, or every 120 minutes; the button shows green when it is activated; 3 seconds long press will disable the biotics operation and the color will change to red; When the biotics inside the unit used out, the button starts to blink in red every 1 second. See #9 for the details of bottle replacement

Maintenance of the BA-2080

⚠ Please unplug the power plug before performing the following operations!

9. H13 Filter and biotic bottle replacement:

In order to ensure the effective use of the air purifier, please be sure to replace the new filter as soon as possible after the filter indicator is red. And press the Timer and Night Mode button together (🌙 + 🌃), the warning will be cleared and indicator will be on OFF status

- 1> Open the back cover of the high-efficiency filter: grab the handle of the back cover and lift it up to open the back cover of the H13 filter.

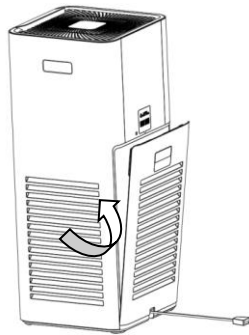

- 2> To unlock the filter lock: Hold the filter lock block and pull it out. When pulled out, the filter unlocks and descends.

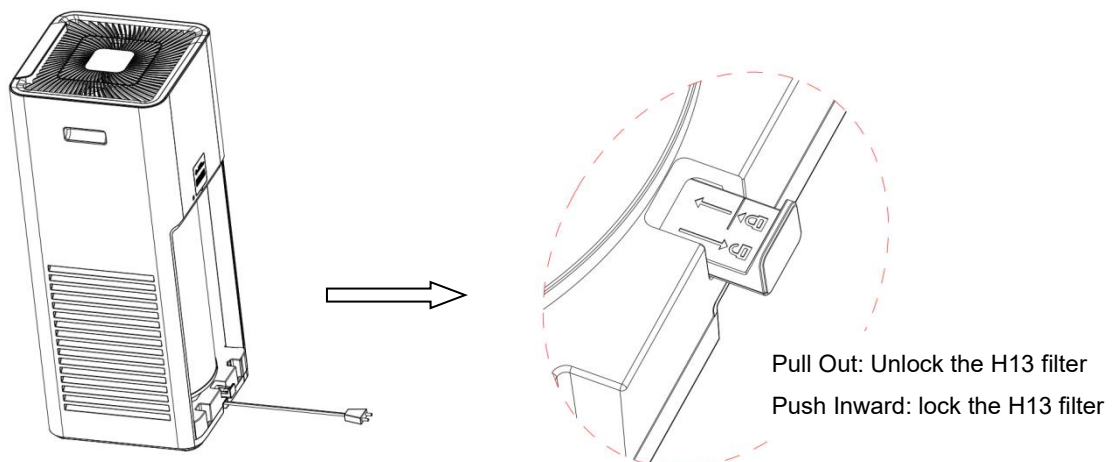

- 3> Take out the filter: Hold the filter with both hands and take it out.
- 4> Slide the bottle out by holding the notch on the bottle adapter and refill.
- 5> Insert the bottle back by aligning the lips on the adapter with the channels on the fitting part.

BA-2080 – The hybrid Indoors Purification device

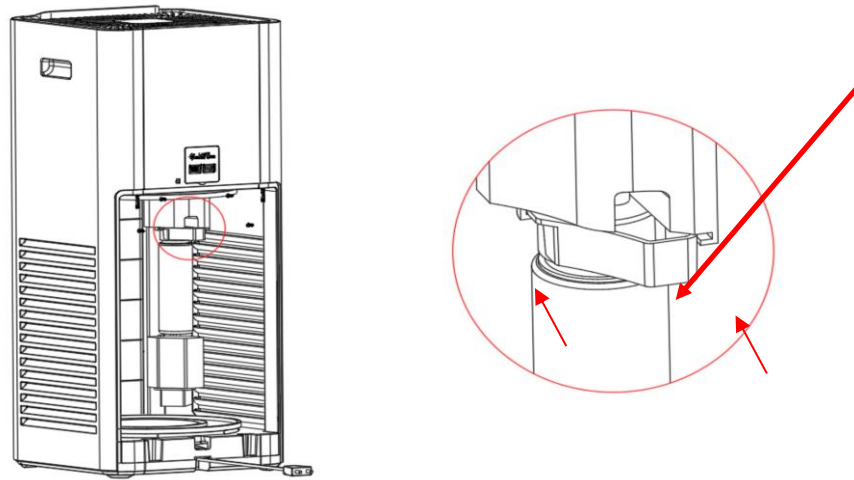

6> Load the new H13 filter: Place the new H13 filter on the locking tray. (Note: It is necessary to put filter with the pull tab towards to the user)

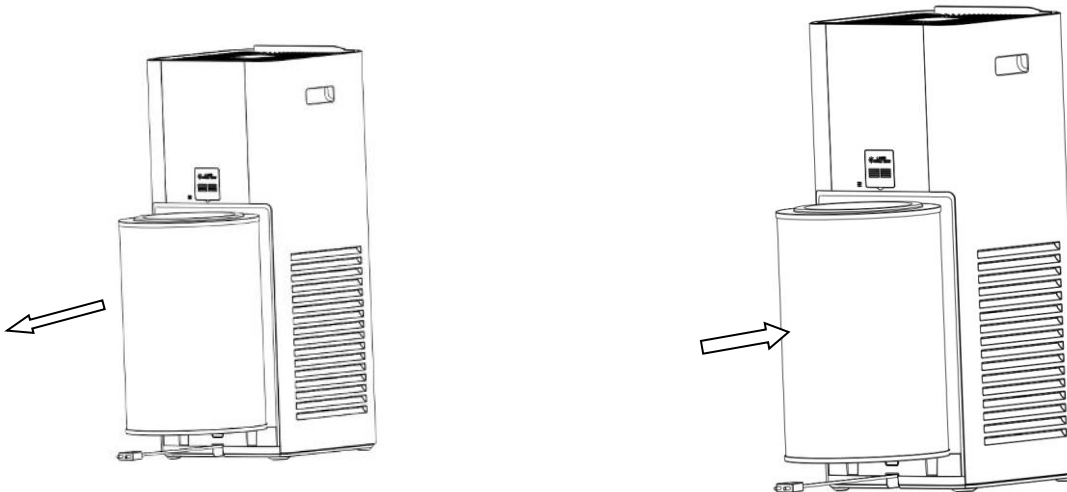

7> Lock the H13 filter: push the filter locking block inward as show below

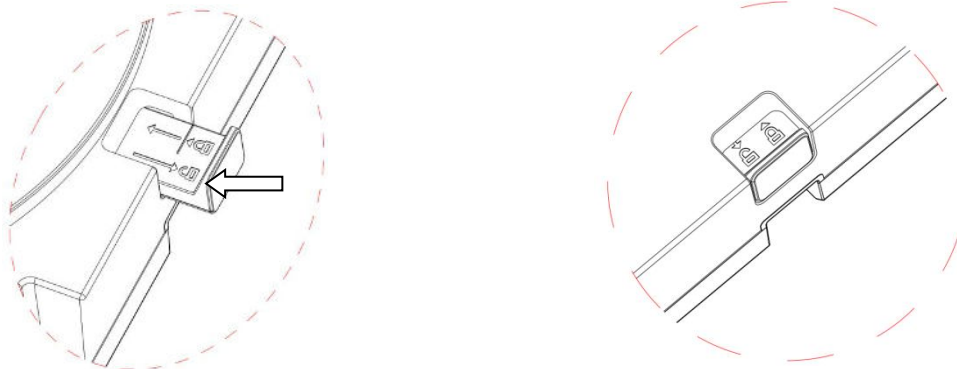

8> Install the back filter cover

BA-2080 – The hybrid Indoors Purification device

- 8.1. The two positioning hooks at the bottom of the back cover are inserted into the slots of the base;
- 8.2. Grab the handle with your hand and push it toward the machine, a “CLICK” to be heard when the cover is on the right position

